

Polarisation of auroral line emissions on Earth's : a review

H. Lamy¹,
M. Barthélemy², J. Lilensten²,
and G. Cessateur¹

—
¹ Belgian Institute for Space Aeronomy, Brussels, Belgium

² IPAG, University of Grenoble, France
—

Vrdnik, Serbia, 3 June 2019



Outline

- **Polarisation of auroral lines**
 - Context and theory for the polarisation of the red line at 630.0 nm
- **Observations and results using a Steerable Photo Polarimeter (SPP)**
 - DoLP
 - AoLP
- **Combination of the theory for red line polarisation with a kinetic transport model for electrons to try to reconcile observations and theoretical predictions**
- **New spectropolarimeter and first attempt to measure the polarisation of the blue line at 427.8 nm**
- **Summary & perspectives**

Auroral lines: the oxygen forbidden lines and polarisability

Green line $O(^1S) - O(^1D)$ 557.7 nm

- $2s^2 2p^4 ^1S_0 - 2s^2 2p^4 ^1D_2$ is a E2 transition
 - upper level with total kinetic momentum $J = 0$
 - only one Zeeman sublevel $M = 0$, hence no polarisation!

Red line $O(^1D) - O(^3P)$ 630.0 nm

- $e^- + O \rightarrow O(^1D) + e^-$ (Meier et al., 1989)
- $2s^2 2p^4 ^1D_2 - 2s^2 2p^4 ^3P_2$ is a M1/E2 transition
 - upper level with $J = 2$
 - 5 Zeeman sublevels
 - impact polarisation possible!
 - Long lifetime 110 s, excitation threshold 1.967 eV

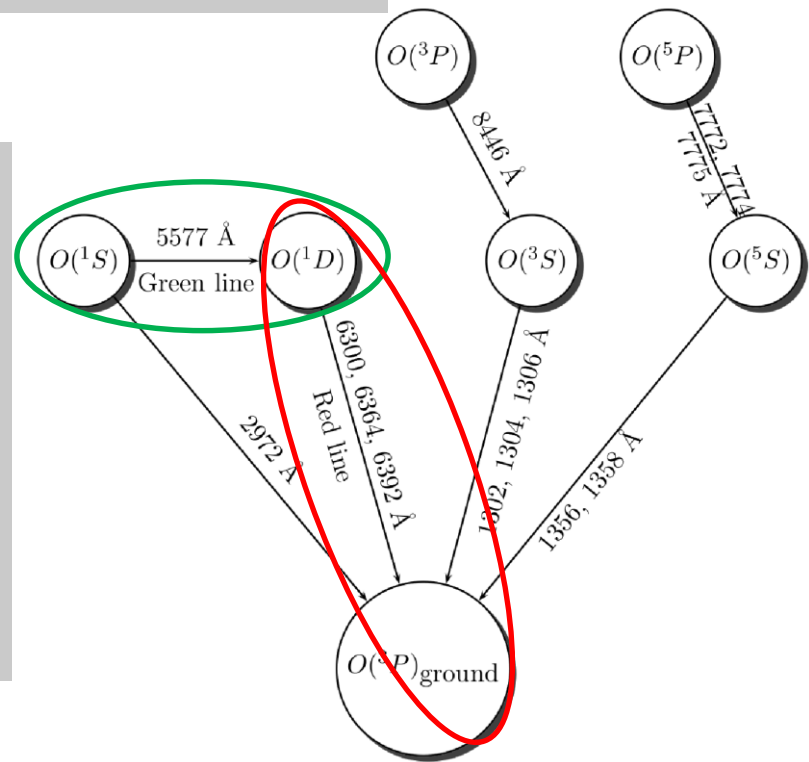

Theory of the auroral red line polarisation

- **Theoretical Interpretation (Bommier et al., Ann. Geophys., 2011)**
 - Theory for one electron impacting a single oxygen atom
 - Semi-classical theory for a quadrupolar electric/magnetic dipole transition
 - Calculations of electron-impact cross sections (for alignment and excitation) and impact polarisation P

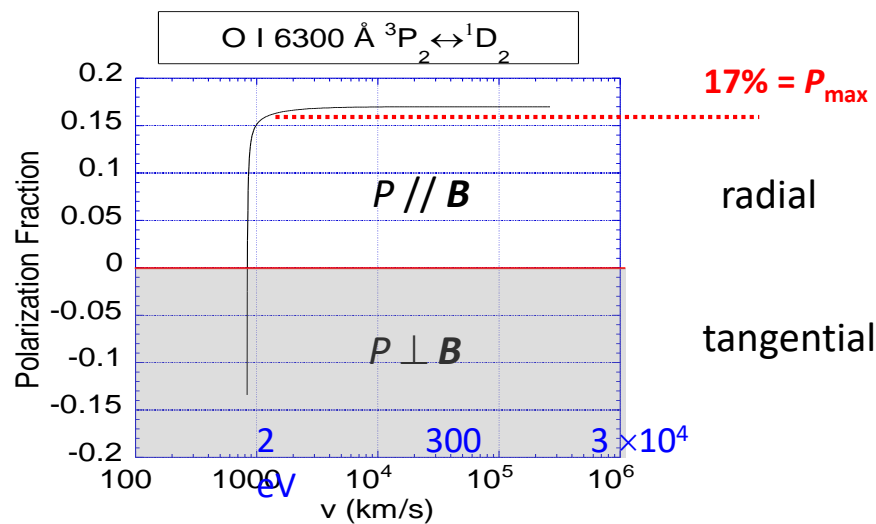
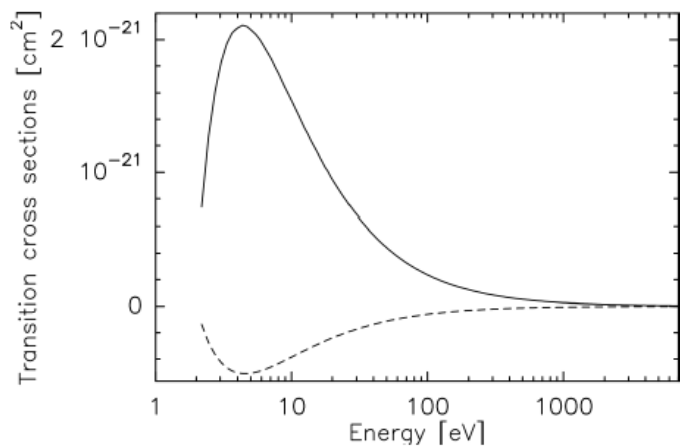

$$\eta = C_{\eta} \frac{\sigma(0 \rightarrow 2)}{\sigma(0 \rightarrow 0)}$$



$$DoLP = \frac{Q}{I} = \frac{3\eta}{1 - \eta}$$

Observation the red line polarisation: campaigns

Several campaigns were organized between 2006 and 2015 in the Svalbard archipelago, Norway, 78° N

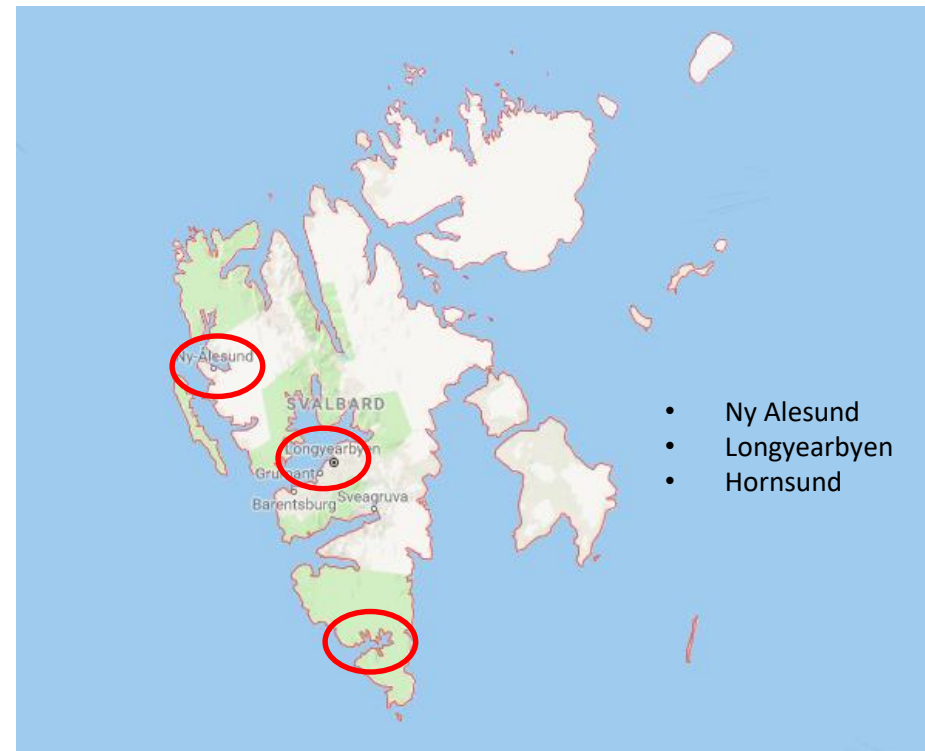

Located inside the auroral oval, in the polar cap, where low-energy electrons precipitate all the time (“polar rain”)

Observing the red line polarisation: instrument

Photo-polarimeter

- Steerable Polarisation Photomultiplier (SPP), built at Oslo University (UiO), J. Moen et al.
- Includes 2 channels and a pan-tilt unit

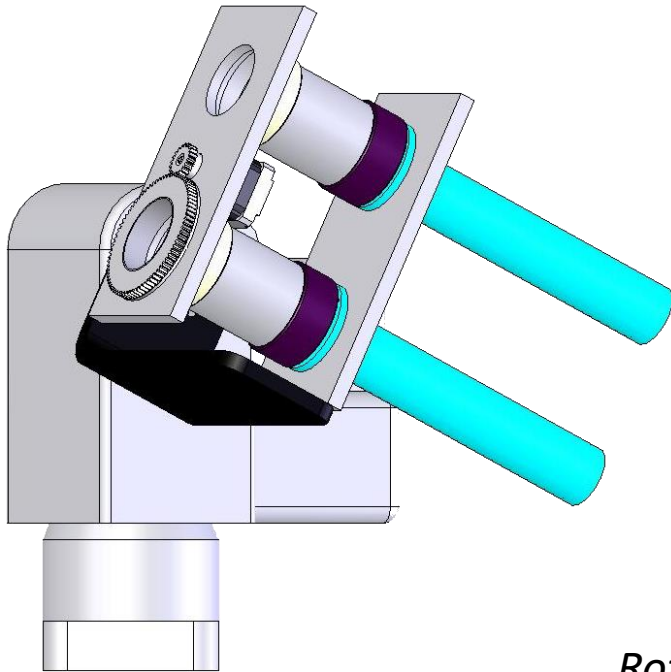

- Channel 1:** - Red filter at 630.0 nm (FWHM=1nm)
- Linear polarisation analyser (1 t/4.02s)
- Channel 2:** - Same with no polarisation filter
- Reference channel for intensity

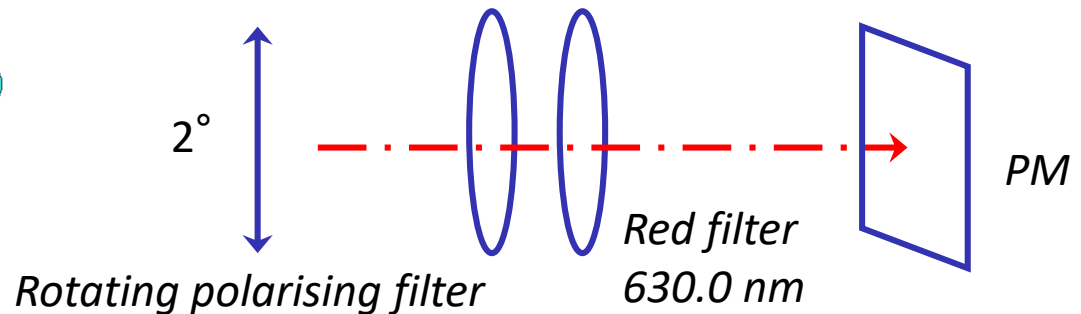

Observing the red line polarisation: geometry

Geometry of the observations

- Pointing \perp to the MF line at ~ 220 km altitude
 - **Longyearbyen**, 15° elevation
 - **Hornsund**, 23° elevation

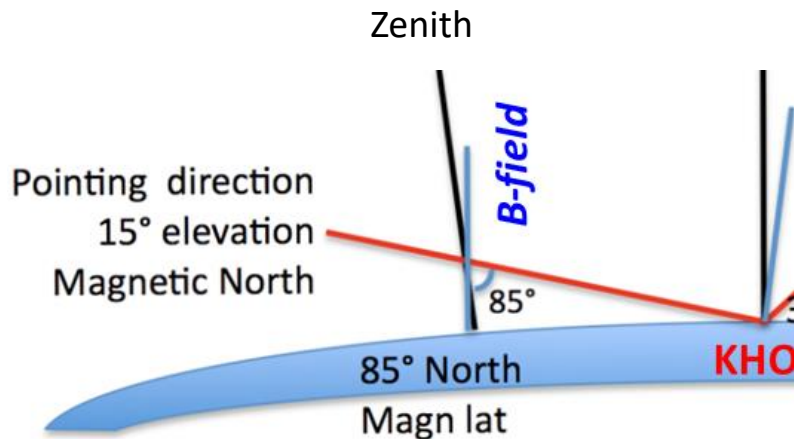

$SZA > 108^\circ$



No contamination
by Rayleigh
scattering of
sunlight in upper
atmosphere

Data analysis

Averaging

- Red points: raw data
- Green points : average on 8 consecutive filter rotations to increase S/N

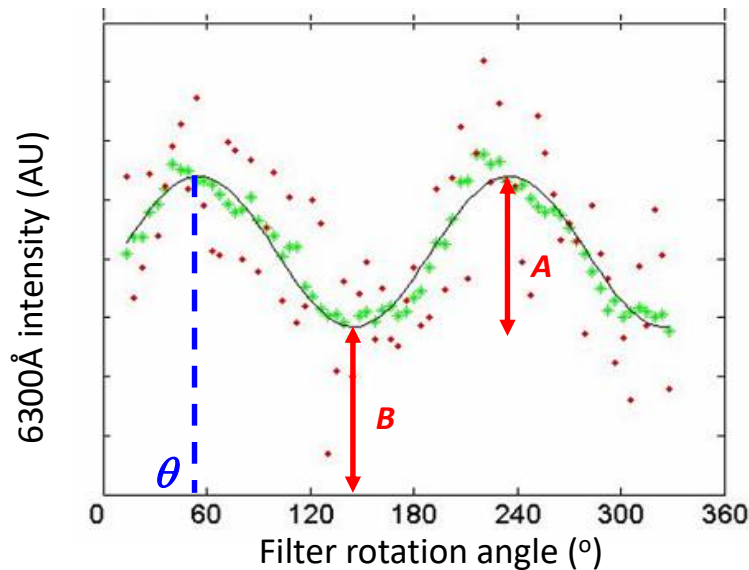

$$f(\alpha) = A \cos^2(\alpha - \theta) + B$$

$$P = \frac{I_{\max} - I_{\min}}{I_{\max} + I_{\min}} = \frac{A}{2B + A}$$

Results for DoLP : Hornsund 2010-2011 (Lilensten et al, 2013)

Main characteristics

- $\text{SZA} > 108^\circ \rightarrow$ no Rayleigh scattering
- During intense auroral event, DoLP strongly decreases
- Values of DoLP much smaller than theoretical predictions

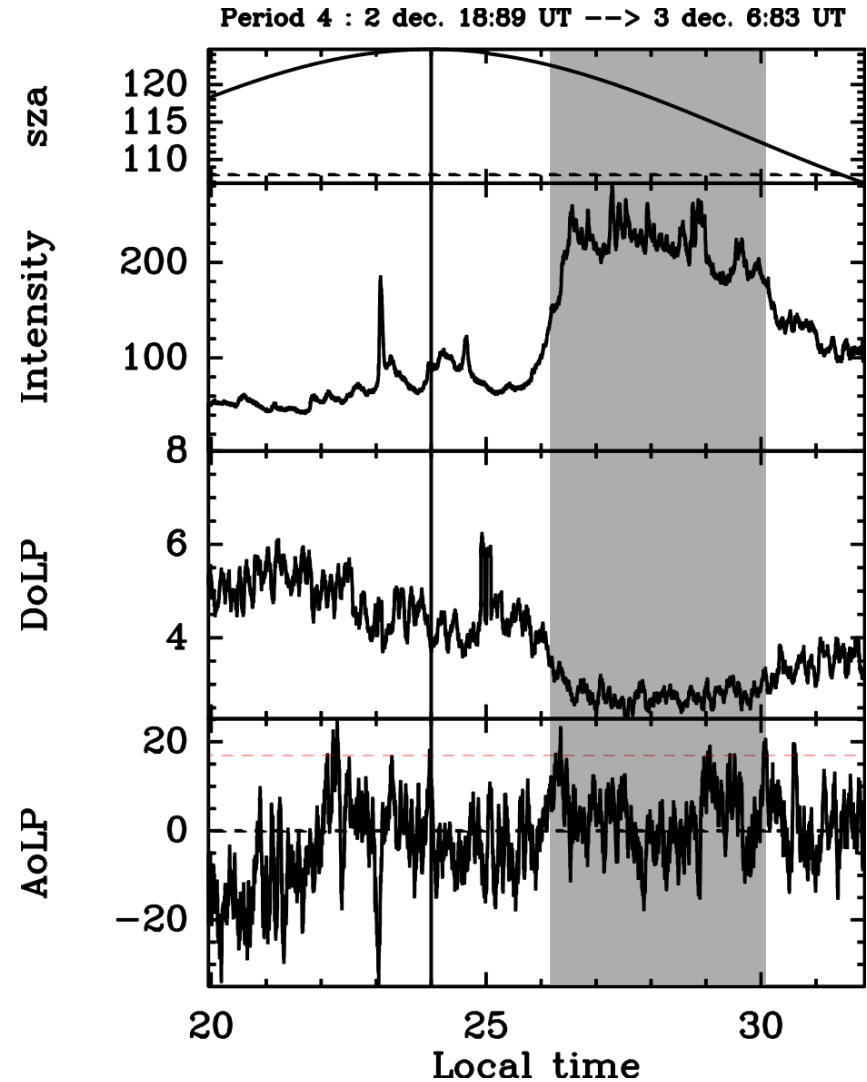

Combination of the theory with an electron transport code

- This electron transport code = TRANSSOLO (see e.g. Liliensten et al 2013b).
- A kinetic transport equation is solved along the MF line to obtain **the electron flux $\Phi(E,z,\vartheta)$** at each altitude z and for energies E and pitch angle ϑ
- Inputs of this code : atmospheric neutral model, electron impact cross sections, and flux of precipitating electrons at the top of the ionosphere.

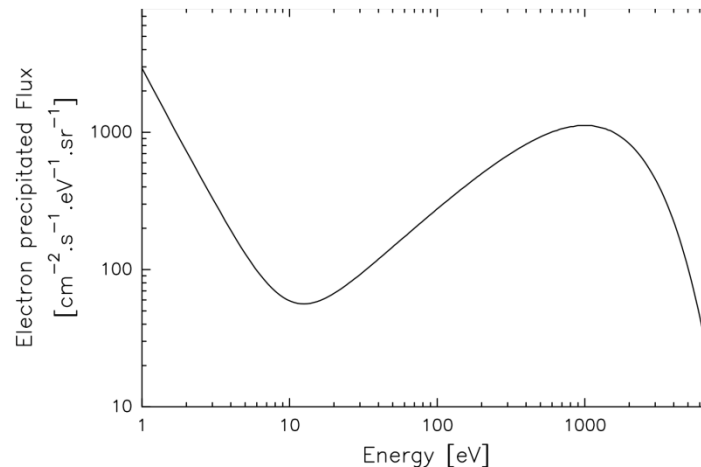

- Many outputs among which **the electron density profile $n_e(z)$** which can be directly compared to data from incoherent scatter radar such as EISCAT UHF radar (Tromsø).

Combination of the theory with an electron transport code

- Other processes compete with the electron impact to populate the upper level of the line (e.g. dissociative recombination of O_2^+ with thermal electrons, ...) which will decrease the polarisation (isotropic processes)
- Moreover the electrons are not fully directive : they have a distribution of pitch angles around the MF line

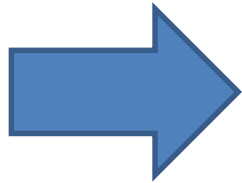

$$\eta(z) = C_\eta \cdot A(z) \cdot R_{coll}(z)$$

$$A(z) = \frac{\int \int dE d\theta \sin \theta \Phi(z, E, \theta) \frac{1}{2} (3 \cos^2 \theta - 1) \sigma(0 \rightarrow 2)}{\int \int dE d\theta \sin \theta \Phi(z, E, \theta) \sigma(0 \rightarrow 0)}$$

$$R_{coll}(z) = \frac{P_{coll}(z)}{P_{tot}(z)}$$

Production of red line through collisions with electrons

Production of red line through all mechanisms

Combination of the theory with an electron transport code

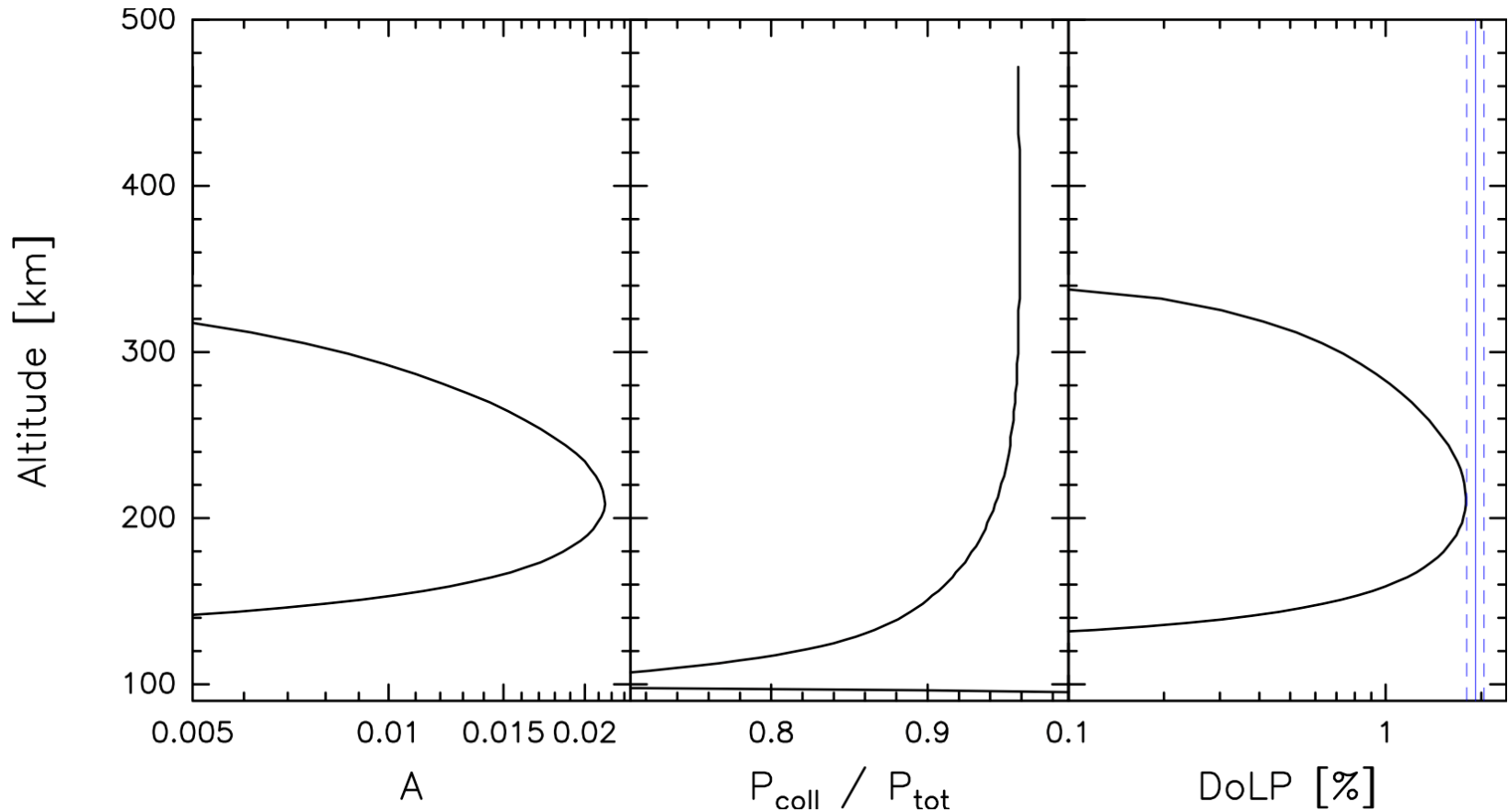

But comparison is not so simple ... because DoLP measured is the integrated value along the LOS, hence with contributions from several MF lines

AoLP results: Ny Alesund, Winter 2014 (Lilensten et al, 2016)

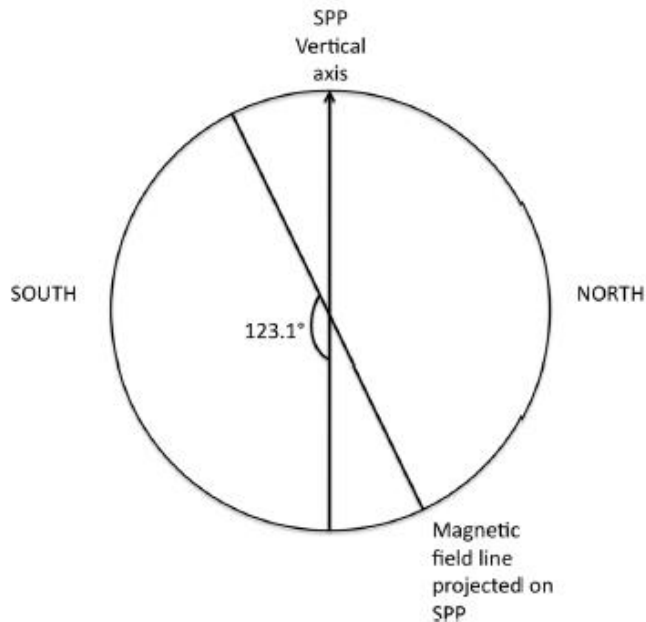

Projection on the FOV of SPP of the local MF line direction crossing the point at 220 km altitude when SPP was pointing with an elevation of 30° toward magnetic West

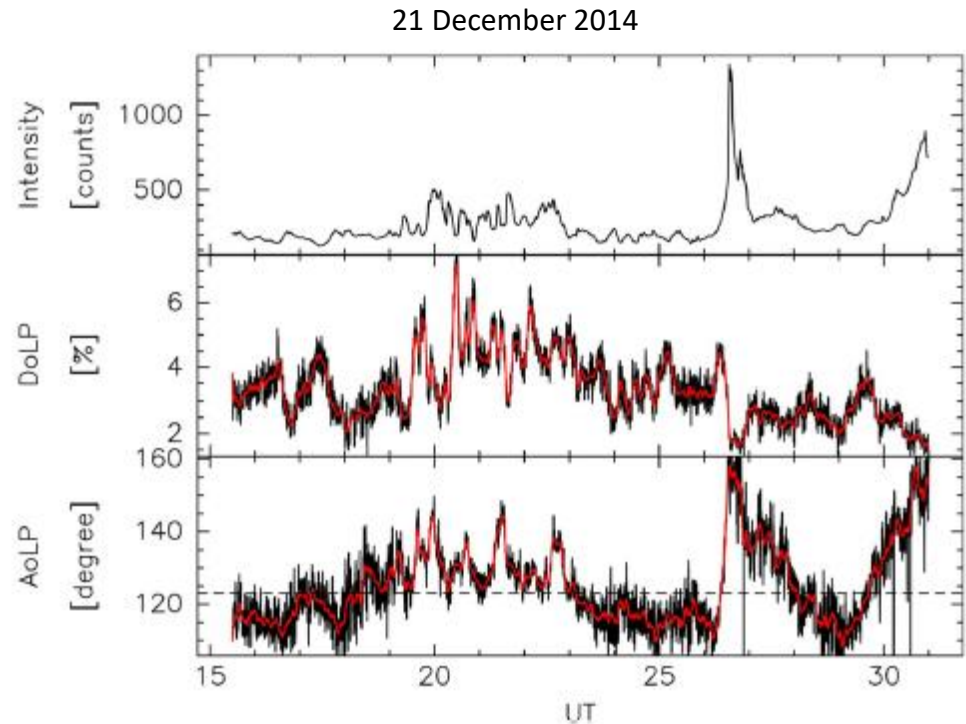

- Weak but permanent auroral activity during most of the time
- DoLP strongly decreases during a strong event
- AoLP strongly rotates as well

Comparison between AoLP results and local MF configuration

Only aurora visible to the naked eye

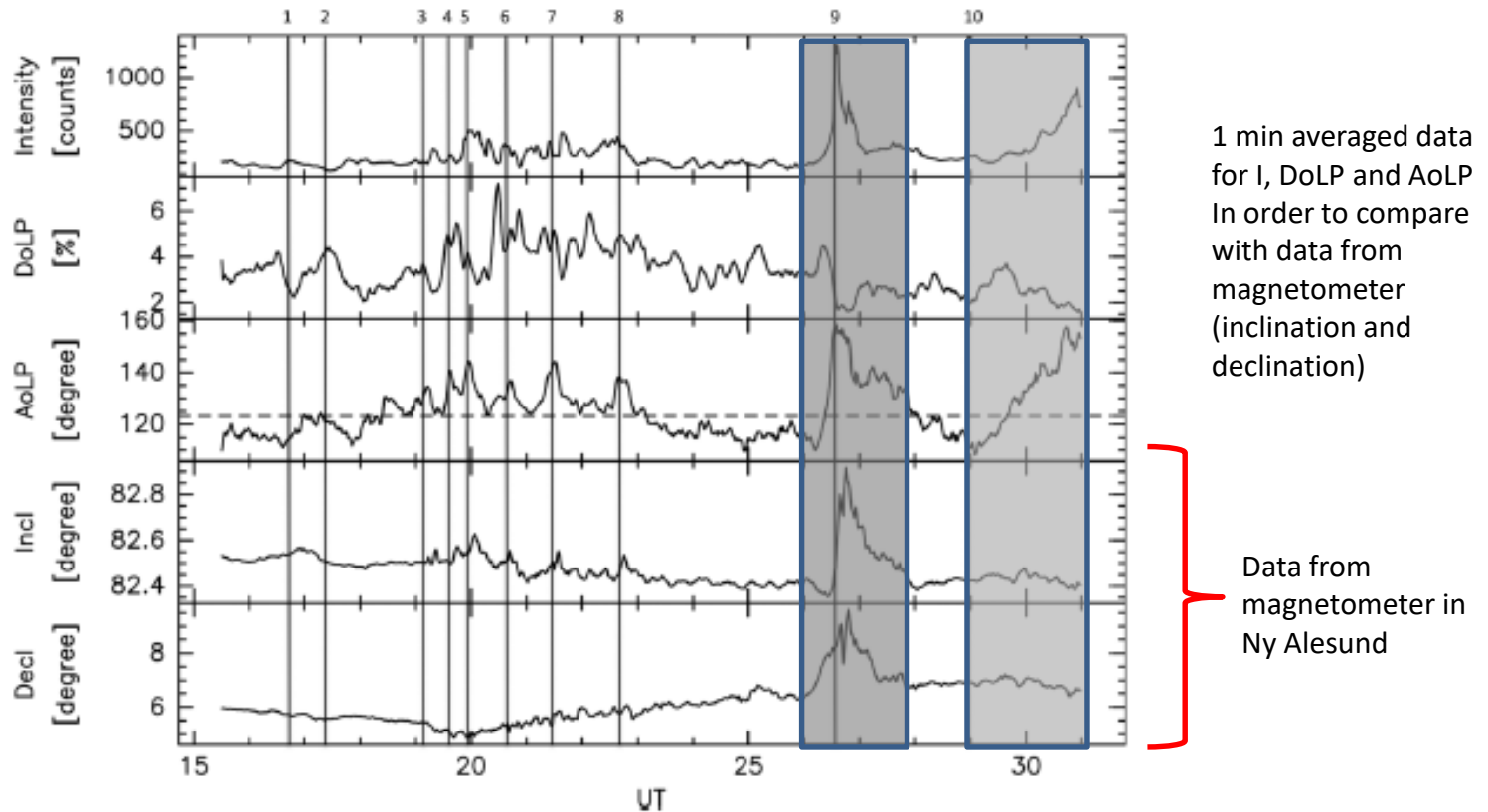

Large-scale event Local event

Measurements of the polarisation of the blue line: why?

- Third most intense auroral emission line (although rarely visible with naked eye)
- Contrary to to red line, the blue line at 427.8 nm (1NG band of N_2^+) is created by impact with electrons only
- It occurs at altitudes below ~ 100 km so is produced by very energetic keV electrons \rightarrow complementary observations with the red line as peaks of emission and energy ranges are very different
- So far no theoretical study of the polarisation of the blue line, so these observations are completely exploratory

Measurements of the polarisation of the blue line: the instrument

- Dedicated spectropolarimeter built by BIRA-IASB and IPAG
- Celestron C8 (f/D=10, D=200 mm)
- Rotating HWR + beam splitter
- Two 600 μm core optical fibers
- Spectrometer + CCD camera
- Polarisation from ~ 400 to 700 nm

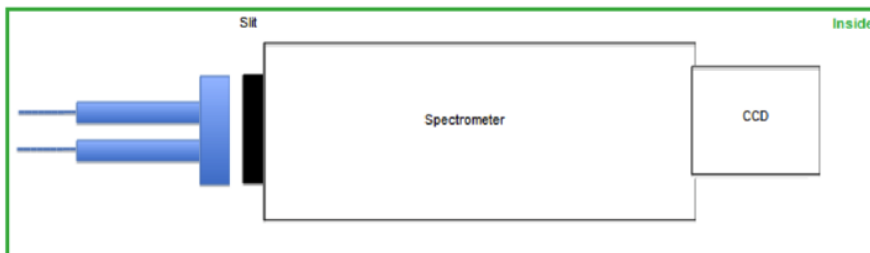
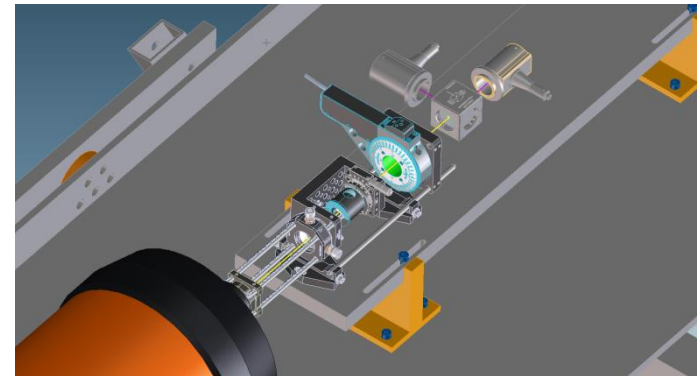
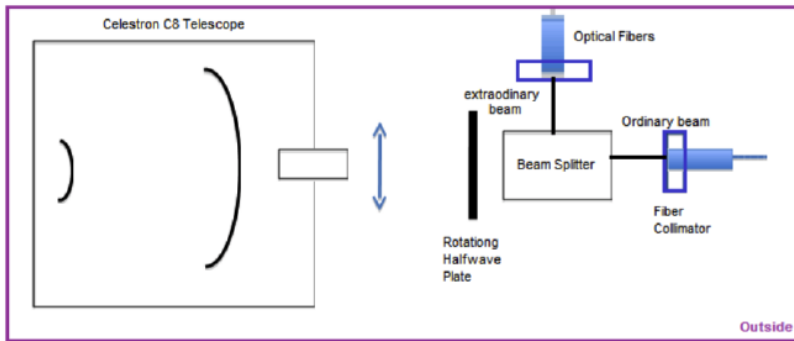

Measurements of the polarisation of the blue line: observation campaign

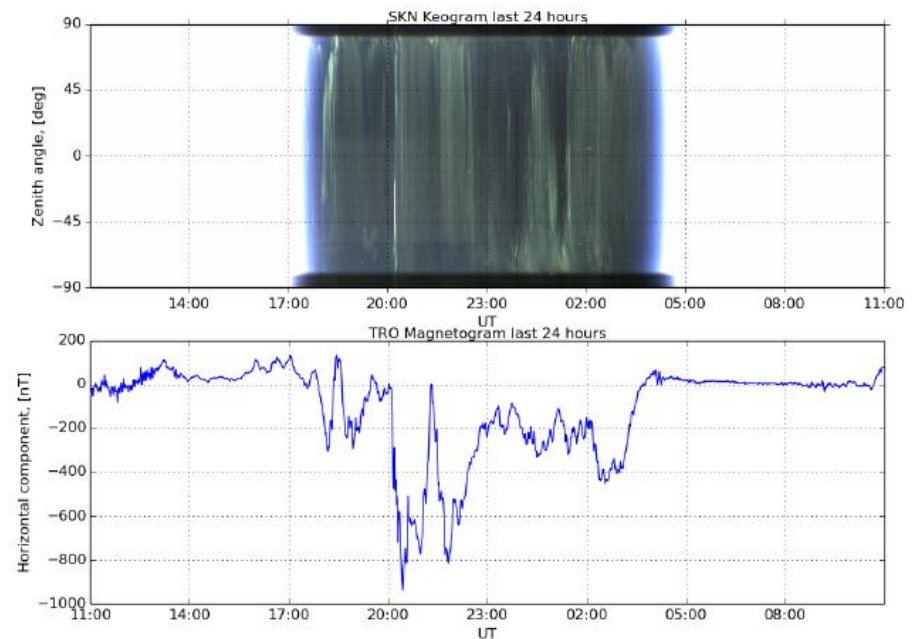
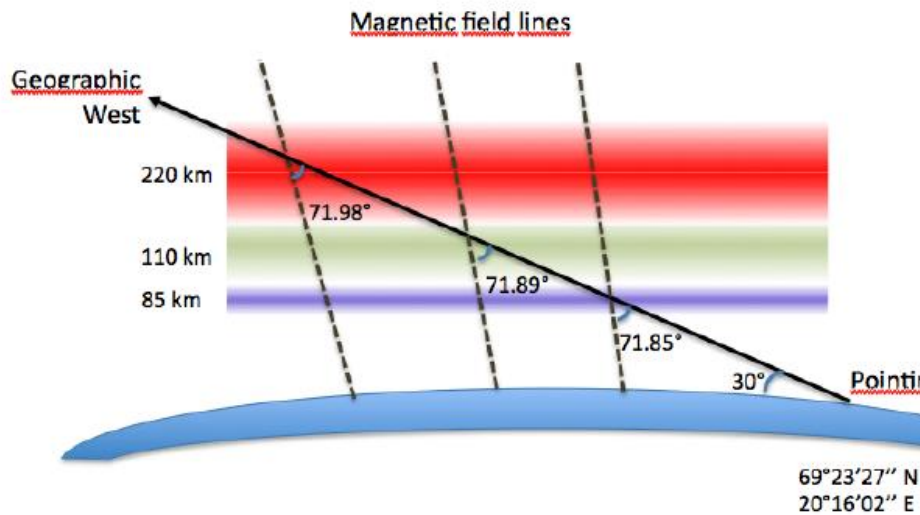

- Geometry optimal for red line \rightarrow kept conservatively for the blue line
- March 1, 2 and 5, 2017 : strong geomagnetic activity

Measure

- We us
- Intens
- Ratio i
 - ✓ P
 - be
 - ✓ P
 - ✓ S
- ✓ We als
 - comput
 - over th
 - depen

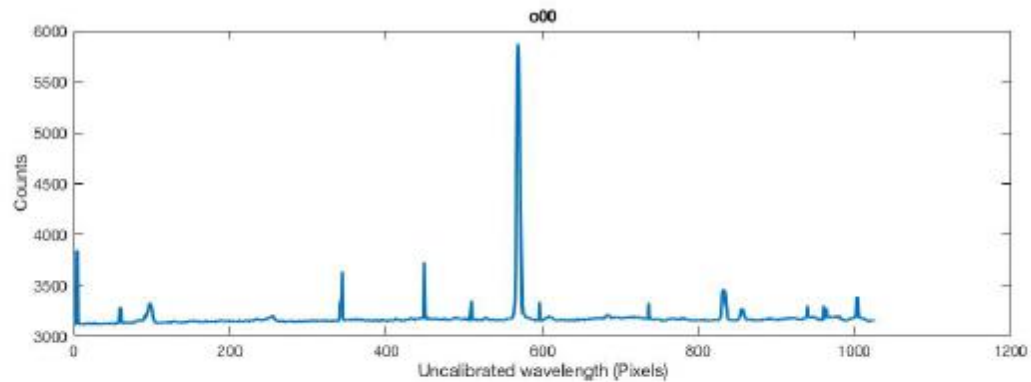

(a) Whole o beam spectrum; HWR angle=0°

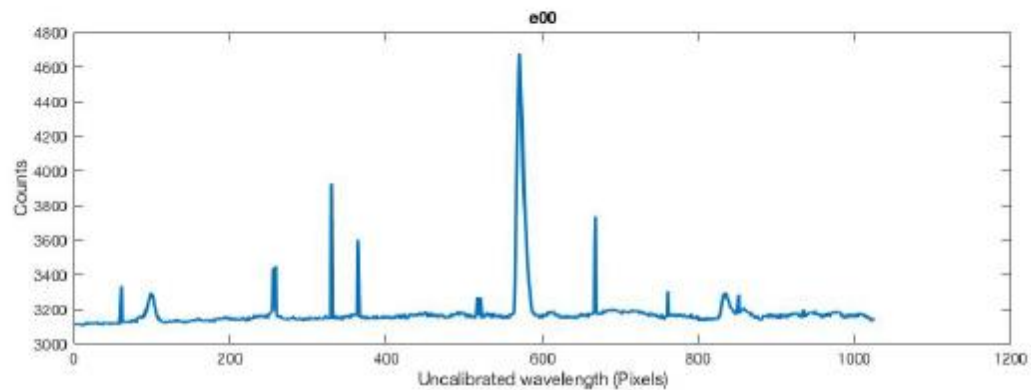

(b) Whole e beam spectrum; HWR angle=0°

- ✓ Due to poor S/N ratio, we needed to integrate 600 seconds for each HWR orientation, therefore giving a time resolution of only ~ 40 mins

7.5°

nd
ted
not

Measurements of the polarisation of the blue line: results

Date	Time LT	p_r (%)	p_d (%)	σ_{p_r} (%)	p_r/σ_{p_r}	p_{r0} (%)	p_{r0}/σ_{p_r}	L
01-03-2017	20:16:17	1.43	1.42	1.75	0.81	0	0	3
01-03-2017	21:02:01	3.54	3.07	1.50	2.36	3.17	2.11	2
01-03-2017	21:47:19	2.51	2.40	1.00	2.51	2.28	2.28	1
01-03-2017	23:15:39	1.37	1.35	3.26	0.42	0	0	1
01-03-2017	all sets	2.84	2.79	0.78	3.64	2.73	3.5	2

- Debiased polarisation is of $\sim 2-3$ %
- No individual set with a 3σ detection
- A 3σ detection is obtained only when adding all the data sets from an evening.
- However, since the blue line is permanently emitted and the result does not cancel out, this indicates that the blue line is polarised at some (yet undetermined) level
- In any case, the possible origin of the polarisation (diffuse permanent background or discrete auroral arcs in the FOV) cannot be determined with these data

Summary

- **Main results so far**

- Polarisation of red line is intrinsic and was measured with a photo-polarimeter
- In theory, the red line could be polarised up to DoLP = 17%
- In practice, DoLP is much smaller of order of a few % and strongly decreases during intense auroral event
- This can be taken account by combining the theory of red line polarisation with predictions from an electron kinetic transport model
- For that the fluxes of precipitating electrons must be known → data from UHF radar / ALIS
- The AoLP is predicted and observed to be along \mathbf{B} -field but also rotates when intense geomagnetic activity occurs.
- We have carried out first polarimetric measurements of the blue line with a dedicated spectropolarimeter. The results are yet inconclusive

- **Perspectives**

- Improve the design of existing spectropolarimeter or develop a new one with new technology (AOTF?) to increase S/N ratio and decrease exposure time
- Observations with improved version of SPP + several narrow interference filters (including one centered on the blue line)

Imaging polarimeter PLIP (Polar Lights Imaging Polarimeter)

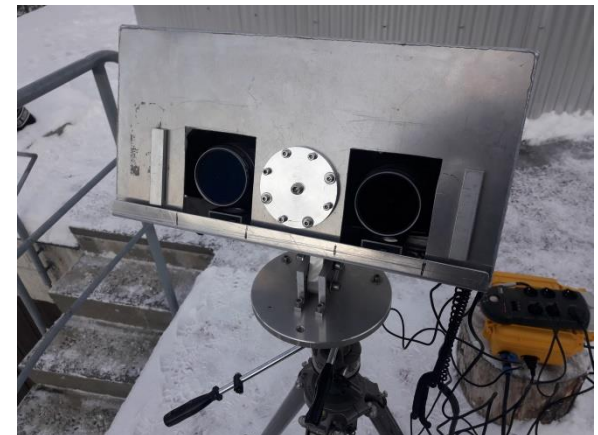

- Work in collaboration with University of Leiden (F. Snik)
- 2 identical cameras looking at the same region of the sky
- One has a polarising filter set vertically, the other one set horizontally \rightarrow Q
- We look at the raw RGB images to roughly estimate the Q parameter in the red, green and blue emission lines.
- The idea is to plot the pseudo-vectors in the R image to map the variations of the local MF line

Imaging polarimeter PLIP : preliminary results

Internship work by Louis Martin at U. Leiden

